

Data sheet

Dimensions

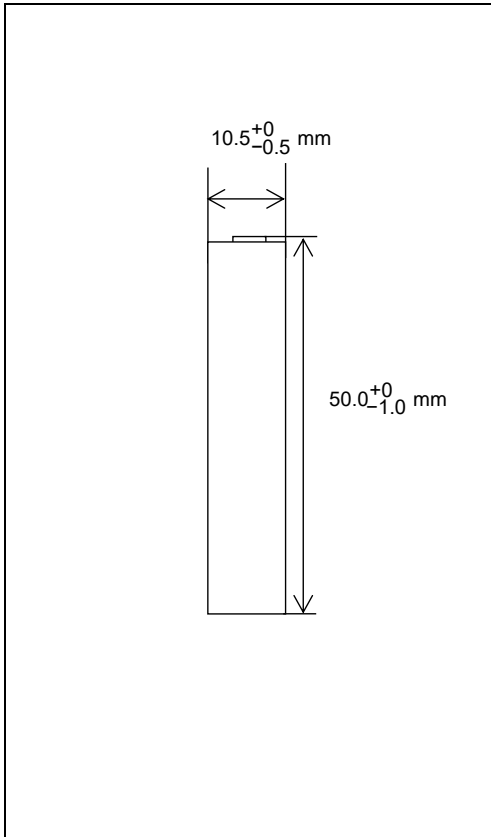

Dimensions (including tube)	Diameter	10.5 +0/ -0.5 mm
	Height	50.0 +0/ -1.0 mm
Approx. Weight (including tube)		14 g
Approx. Internal Impedance at 1kHz 20°C ₅₎		30 mΩ

5) After 3 cycles of charge and discharge under the conditions of 1), followed by the measurement 1~4 hours later.

Capacity

Nominal ₁₎	850 mAh
Minimum ₁₎	760 mAh

1) Single cell capacity under the following condition.

Charge : 76 mA x 16 hours, Discharge : 152 mA (E.V.=1.00 V) at 20 °C

General Specifications

Nominal Voltage		1.2 V	
End Voltage		1.00 V	
Charging Current x Time	Fast Charge ₂₎	850 mA x about 1.1 hours	
Ambient Temp.	Charge Condition ₃₎	Fast Charge ₂₎	0 °C ~ +40 °C
	Discharge Condition ₃₎	Recommended	0 °C ~ +50 °C
Relative Humidity ₄₎		45 % ~ 85 %	

2) Use recommended charging system.

3) Charge or discharge on outside the recommended temperature range may generate the battery degradation.

4) No water condensation.

Storage Conditions

Ambient Temp.	Less than 30 days	-20 °C ~ +50 °C
	Less than 90 days	-20 °C ~ +40 °C
	Less than 1 year	-20 °C ~ +30 °C
Relative Humidity ₆₎		45 % ~ 85 %

6) No water condensation.

Nominal Charge Characteristics

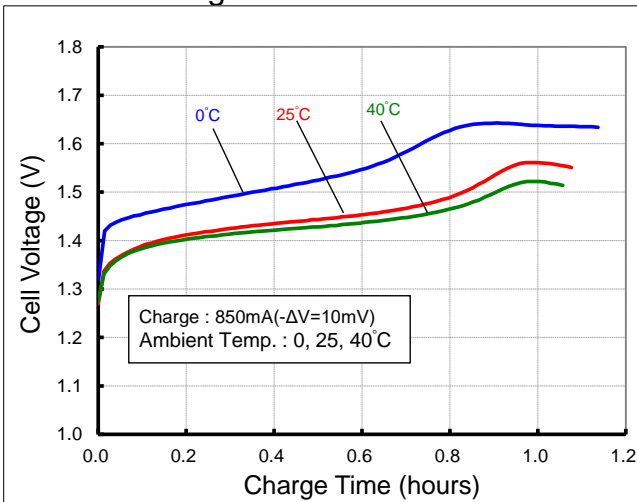

Nominal Discharge Characteristics

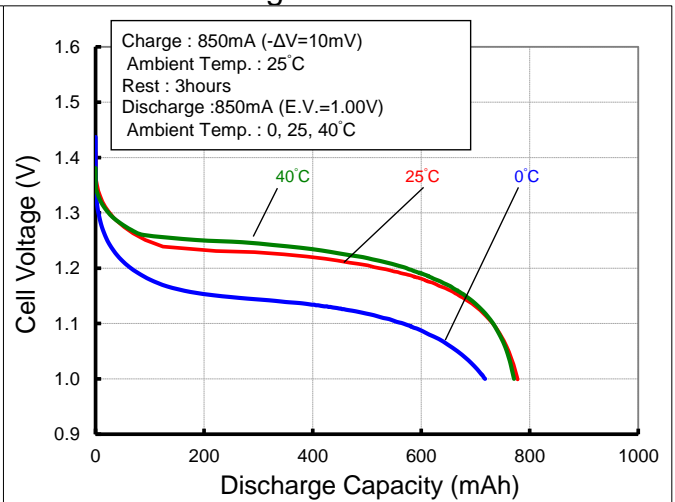

- Single cell performance and lifespan are greatly affected by usage and temperature conditions.
- Test results vary depending on individual cells.
- Each values included in this material are intended to describe performance. They are not guaranteed.